

Sinofair®

产品目录

佛山市华辉电源线材有限公司
SINOFAIR (FOSHAN) POWER CORD CO., LTD

电话：0757-8862 2736
邮箱：limin@sinofair.com.cn
网址：www.sinofair.com.cn



公司简介

- 华辉公司成立于1993年在香港成立，2008年工厂搬迁至美丽的西江河畔佛山市高明区，更名为“佛山市华辉电源线材有限公司”，坐落在佛山市高明区兴洲路18号，占地面积23000平方米。
- 专注生产销售电源线。公司产品已遍布欧洲、美洲、东南亚等国。各类产品技术符合CB、VDE、UL、CSA、AU、KR、GB等行业标准，并取得全球各国认证。
- 第二大类产品USB充电线，有Type-c和Micro两种成熟产品。
- 现公司有员工233名，尖端技术人才6名，品质管控人员20名。年产能达5000万条电源线。是经国家认证的高新科技企业。
- 公司取得体系认证有ISO9001、ISO14001、AEO高级认证等。
- 连续10年被评为年度纳税信用 A 级。
- 公司秉承着“以人为本，质量第一，诚信服务，不断创新”的精神，不断优化企业文化，不断壮大企业队伍，精益求精。为公司持续健康发展奠定坚实的基础。

目录索引

| | 认证 | 标志 | 页码 |
|----|-----------------------------|--------------------|-------|
| 1 | China 中国 | CCC | 4-24 |
| 2 | Amreica/Canada 美国、加拿大 | UL & CUL | 25-43 |
| 3 | Europe 欧洲、俄罗斯 | VDE、SEMKO、KEMA、EAC | 44-55 |
| 4 | Korea 韩国 | KC | 56-62 |
| 5 | Australia 澳洲 | SAA | 63-65 |
| 6 | England、Singapore 英国、新加坡 | BSI | 66-68 |
| 7 | Japan 日本 | JET | 69-71 |
| 8 | Taiwan 台湾 | TW | 72-76 |
| 9 | USB充电线 DC插头 (DC5.5,DC3.5--) | --- | 77-81 |
| 10 | 配套开关 | --- | 82 |
| 11 | 编织线 | --- | 83 |

Sinofair[®]

- China 中国



国标两直插

Type NO(型号) : SF-201

参 数: 6A 250V

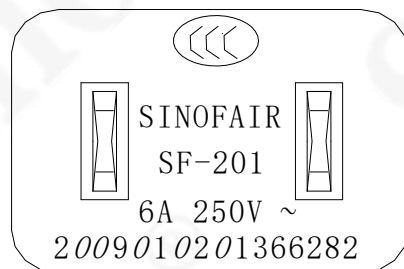

| Applicable Cable(适用电线) | |
|------------------------|-----------------------|
| Type of Cable(电线型号) | Cable Size(规格) |
| 60227 IEC52 (H03VVH2) | 2x0.5mm ² |
| 60227 IEC52 (H03VV) | 2x0.5mm ² |
| 60227 IEC52 (H03VVH2) | 2x0.75mm ² |
| 60227 IEC52 (H03VV) | 2x0.75mm ² |
| 60227 IEC53 (H05VVH2) | 2x0.75mm ² |
| 60227 IEC53 (H05VV) | 2x0.75mm ² |

国标两直插

Type NO(型号) : SF-202

参 数: 10A 250V ~

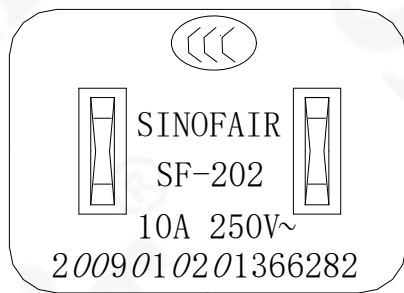

| Applicable Cable(适用电线) | |
|------------------------|-----------------------|
| Type of Cable(电线型号) | Cable Size(规格) |
| 60227 IEC52 (H03VV) | 2×0.75mm ² |
| 60227 IEC52 (H03VVH2) | 2×0.75mm ² |
| 60227 IEC53 (H05VV) | 2×0.75mm ² |
| 60227 IEC53 (H05VVH2) | 2x0.75mm ² |
| 60227IEC53 (H05VV) | 2x1.0mm ² |
| 60227 IEC53 (H05VVH2) | 2x1.0mm ² |

国标两弯插

Type NO(型号) : SF-212

参 数: 6A 250V~

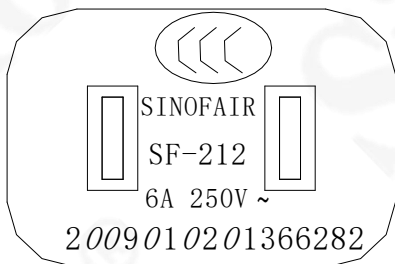

| Applicable Cable(适用电线) | |
|------------------------|-----------------------|
| Type of Cable(电线型号) | Cable Size(规格) |
| 60227 IEC52 (H03VVH2) | 2x0.5mm ² |
| 60227 IEC52 (H03VV) | 2x0.5mm ² |
| 60227 IEC52 (H03VVH2) | 2x0.75mm ² |
| 60227 IEC52 (H03VV) | 2x0.75mm ² |
| 60227 IEC53 (H05VVH2) | 2x0.75mm ² |
| 60227 IEC53 (H05VV) | 2x0.75mm ² |

国标两弯插

Type NO(型号) : SF-212

参 数: 10A 250V ~

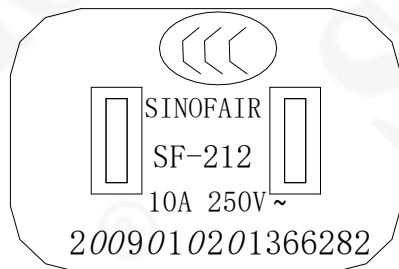

| Applicable Cable(适用电线) | |
|------------------------|-----------------------|
| Type of Cable(电线型号) | Cable Size(规格) |
| 60227 IEC52 (H03VVH2) | 2x0.5mm ² |
| 60227 IEC52 (H03VV) | 2x0.5mm ² |
| 60227 IEC52 (H03VVH2) | 2x0.75mm ² |
| 60227 IEC52 (H03VV) | 2x0.75mm ² |
| 60227 IEC53 (H05VVH2) | 2x0.75mm ² |
| 60227 IEC53 (H05VV) | 2x0.75mm ² |



国标8字尾弯插

Type NO(型号) : SF-213弯插

参 数: 2.5A 250V~

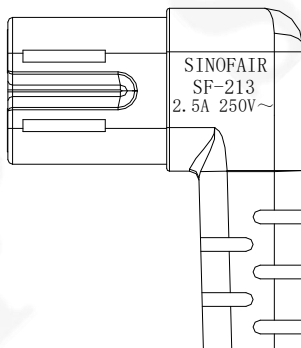

Applicable Cable(适用电线)

Type of Cable(电线型号)

Cable Size(规格)

60227 IEC52 (H03VVH2)

2×0.5mm²

60227 IEC52 (H03VVH2)

2×0.75mm²

60227 IEC53 (H05VVH2)

2×0.75mm²



国标8字尾直插

Type NO(型号) : SF-214 直插

参 数: 2.5A 250V~

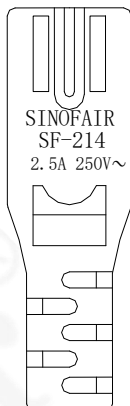

Applicable Cable(适用电线)

Type of Cable(电线型号)

Cable Size(规格)

60227 IEC52 (H03VVH2)

2×0.5mm²

60227 IEC52 (H03VVH2)

2×0.75mm²

60227 IEC53 (H05VVH2)

2×0.75mm²

SF-201/202国标直插 配8字尾
(SF-213弯/SF-214直)

参 数: 2.5A 250V~



| Applicable Cable(适用电线) | |
|------------------------|-----------------------|
| Type of Cable(电线型号) | Cable Size(规格) |
| SF-201+SF-213/SF-214 | |
| 60227 IEC52 (H03VVH2) | 2x0.5mm ² |
| 60227 IEC52 (H03VVH2) | 2x0.75mm ² |
| 60227 IEC53 (H05VVH2) | 2x0.75mm ² |
| SF-202+SF-213/SF-214 | |
| 60227 IEC52 (H03VVH2) | 2x0.75mm ² |
| 60227 IEC53 (H05VVH2) | 2x0.75mm ² |



SF-212 国标弯插 配8字尾

(SF-213弯/SF-214直)

参 数：2.5A 250V~



Applicable Cable(适用电线)

Type of Cable(电线型号)

Cable Size(规格)

60227 IEC52 (H03VVH2)

2×0.5mm²

60227 IEC52 (H03VVH2)

2×0.75mm²

60227 IEC53 (H05VVH2)

2×0.75mm²



国标三插

Type NO(型号) : SF-301/SF-307

参 数: 10A 250V~

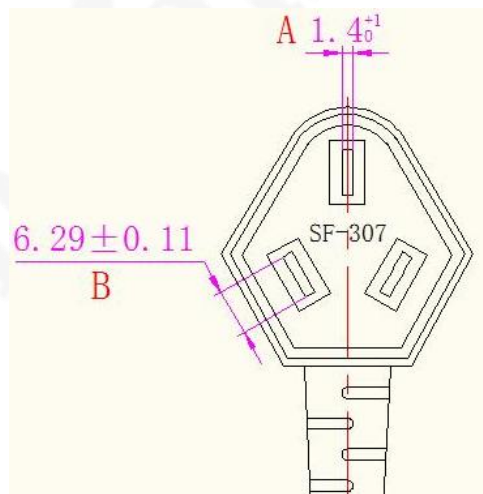

Applicable Cable(适用电线)

| Type of Cable(电线型号) | Cable Size(规格) |
|---------------------|-----------------------|
| 60227 IEC52 (H03VV) | 3×0.5mm ² |
| 60227 IEC52 (H03VV) | 3×0.75mm ² |
| 60227 IEC53 (H05VV) | 3x0.75mm ² |
| 60227 IEC53 (H05VV) | 3x1.0mm ² |



国标三直插

Type NO(型号) : SF-314

参 数: 10A 250V ~

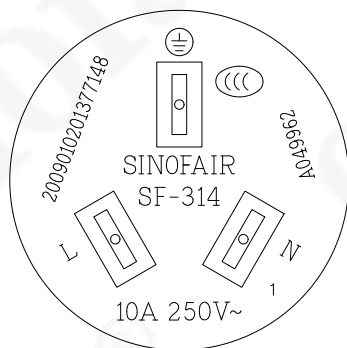

| Applicable Cable(适用电线) | |
|------------------------|-----------------------|
| Type of Cable(电线型号) | Cable Size(规格) |
| 60227 IEC52 (H03VV) | 3×0.5mm ² |
| 60227 IEC52 (H03VV) | 3×0.75mm ² |
| 60227 IEC53 (H05VV) | 3x0.75mm ² |
| 60227 IEC53 (H05VV) | 3x1.0mm ² |



国标烟斗式三插

Type NO(型号) : SF-310

参 数: 10A 250V ~

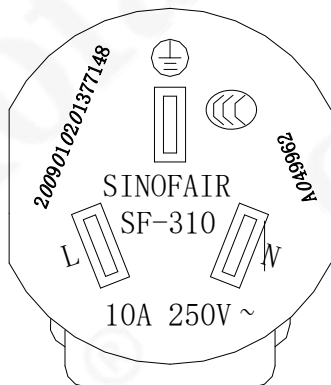

Applicable Cable(适用电线)

| Type of Cable(电线型号) | Cable Size(规格) |
|---------------------|-----------------------|
| 60227 IEC52 (H03VV) | 3x0.5mm ² |
| 60227 IEC52 (H03VV) | 3x0.75mm ² |
| 60227 IEC53 (H05VV) | 3x0.75mm ² |
| 60227 IEC53 (H05VV) | 3x1.0mm ² |
| 60227 IEC53 (H05VV) | 3x1.5mm ² |



国标烟斗式三插

Type NO(型号) : SF-302

参 数: 16A 250V ~

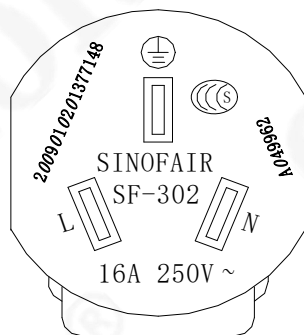

Applicable Cable(适用电线)

| Type of Cable(电线型号) | Cable Size(规格) |
|---------------------|-----------------------|
| 60227 IEC53 (H05VV) | 3x0.75mm ² |
| 60227 IEC53 (H05VV) | 3x1.0mm ² |
| 60227 IEC53 (H05VV) | 3x1.5mm ² |

国标品字尾插

Type NO(型号) : SF-309

品字尾插额定值: 10A 250V ~



| Applicable Cable(适用电线) | |
|------------------------|-----------------------|
| Type of Cable(电线型号) | Cable Size(规格) |
| 60227 IEC53 (H05VV) | 3x0.75mm ² |
| 60227 IEC53 (H05VV) | 3x1.0mm ² |
| 60227 IEC53 (H05VV) | 3x1.5mm ² |



米老鼠尾插

Type NO(型号) : SF-313 (米)

米老鼠插额定值: 2.5A/ 250V ~

| Applicable Cable(适用电线) | |
|------------------------|-----------------------|
| Type of Cable(电线型号) | Cable Size(规格) |
| 60227 IEC52 (H03VV) | 3x0.75mm ² |
| 60227 IEC53 (H05VV) | 3x0.75mm ² |
| 60227 IEC53 (H05VV) | 3x1.0mm ² |
| 60227 IEC53 (H05VV) | 3x1.5mm ² |

国标三插 配品字尾

Type NO(型号) : SF-301/SF-310 +SF-309

参 数: 10A 250V ~



| Applicable Cable(适用电线) | |
|------------------------|-----------------------|
| Type of Cable(电线型号) | Cable Size(规格) |
| SF-310+SF-309 | |
| 60227 IEC53 (H05VV) | 3x0.75mm ² |
| 60227 IEC53 (H05VV) | 3x1mm ² |
| 60227 IEC53 (H05VV) | 3x1.5mm ² |
| SF-301+SF-309 | |
| 60227 IEC53 (H05VV) | 3x0.75mm ² |
| 60227 IEC53 (H05VV) | 3x1mm ² |

国标三插直插 配 品字尾插/米老鼠插

Type NO(型号) : SF-314+SF-309 (品) /SF-313米

SF-314直插额定值: 10A 250V ~

品字尾插额定值: 10A 250V ~

米老鼠插额定值: 2.5A 250V ~



| Applicable Cable(适用电线) | |
|------------------------|-----------------------|
| Type of Cable(电线型号) | Cable Size(规格) |
| SF-314+SF-313 | |
| 60227 IEC52 (H03VV) | 3x0.75mm ² |
| 60227 IEC53 (H05VV) | 3x0.75mm ² |
| 60227 IEC53 (H05VV) | 3x1mm ² |
| SF-314+SF-309 | |
| 60227 IEC53 (H05VV) | 3x0.75mm ² |
| 60227 IEC53 (H05VV) | 3x1mm ² |

国标三插+品字尾

Type NO(型号) : SF-302+SF-309

国标三插额定值: 16A 250V ~

品字尾额定值: 10A 250V ~



| Applicable Cable(适用电线) | |
|------------------------|-----------------------|
| Type of Cable(电线型号) | Cable Size(规格) |
| 60227 IEC53 (H05VV) | 3x0.75mm ² |
| 60227 IEC53 (H05VV) | 3x1.0mm ² |
| 60227 IEC53 (H05VV) | 3x1.5mm ² |

国标三插 配 米老鼠插

Type NO(型号) : SF-301/SF-310+SF-313

国标三插额定值: 10A 250V ~

米老鼠插额定值: 2.5A 250V ~



| Applicable Cable(适用电线) | |
|------------------------|-----------------------|
| Type of Cable(电线型号) | Cable Size(规格) |
| SF-301+SF-313 | |
| 60227 IEC52 (H03VV) | 3x0.75mm ² |
| 60227 IEC53 (H05VV) | 3x0.75mm ² |
| 60227 IEC53 (H05VV) | 3x1.0mm ² |
| SF-310+SF-313 | |
| 60227 IEC52 (H03VV) | 3x0.75mm ² |
| 60227 IEC53 (H05VV) | 3x0.75mm ² |
| 60227 IEC53 (H05VV) | 3x1.0mm ² |
| 60227 IEC53 (H05VV) | 3x1.5mm ² |

国标三插+米老鼠

Type NO(型号) : SF-302+SF-313

国标三插额定值: 16A 250V ~

米老鼠额定值: 2.5A 250V ~



| Applicable Cable(适用电线) | |
|------------------------|-----------------------|
| Type of Cable(电线型号) | Cable Size(规格) |
| 60227 IEC53 (H05VV) | 3x0.75mm ² |
| 60227 IEC53 (H05VV) | 3x1.0mm ² |
| 60227 IEC53 (H05VV) | 3x1.5mm ² |

中规 电线系列

GB/T 5023.5-2008/IEC 60227-5:2003

| 序号 | 规格 |
|----|---|
| 1 | 60227 IEC52 (H03VV/H03VVH2) 2芯*0.5~0.75mm ² |
| 2 | 60227 IEC52 (H03VV) 3芯*0.5~0.75mm ² |
| 3 | 60227 IEC53 (H05VV) 2芯*0.75~1.0~1.5mm ² |
| 4 | 60227 IEC53 (H05VV) 3芯*0.75~1.0~1.5mm ² |
| 5 | 60227 IEC53 (H05VV) 4芯*0.75~1.0~1.5mm ² |

Sinofair[®]

- America/Canada 美国/加拿大



美规两插(1-15p)

Type NO(型号) : SF-301(非极性)

参数: 10A 125V~/13A 125V~

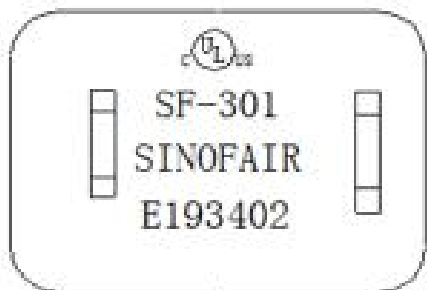

| Applicable Cable(适用电线) | |
|--|----------------|
| Type of Cable(电线型号) | Cable Size(规格) |
| SPT-1、NISPT-1、SPT-2、NISPT-2、SPT-2带编织、SVT带编织、SJT带编织、HPN、SJT、SJTO、SVT、SVTO、SVTOO、SJTOO、SJTW、SJTOW、SJTOOW | 2×18AWG |
| SPT-2、NISPT-2、SPT-2带编织、SVT带编织、SJT带编织、HPN、SJT、SJTO、SJTOO、SJTW、SJTOW、SJTOOW | 2×16AWG |

美规两插(1-15p)

Type NO(型号) : SF-301(极性)

参数: 10A 125V~/13A 125V~

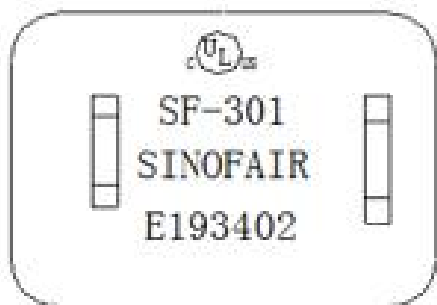

Applicable Cable(适用电线)

| Type of Cable(电线型号) | Cable Size(规格) |
|--|----------------|
| SPT-1、NISPT-1、SPT-2、NISPT-2、SPT-2带编织、SVT带编织、SJT带编织、HPN、SJT、SJTO、SVT、SVTO、SVTOO、SJTOO、SJTW、SJTOW、SJTOOW | 2×18AWG |
| SPT-2、NISPT-2、SPT-2带编织、SVT带编织、SJT带编织、HPN、SJT、SJTO、SJTOO、SJTW、SJTOW、SJTOOW | 2×16AWG |

美规三插(5-15p)

Type NO(型号) : SF-303

参数: 10A 125V~/13A 125V~/15A 125V



| Applicable Cable(适用电线) | |
|---|----------------|
| Type of Cable(电线型号) | Cable Size(规格) |
| SPT-1、SPT-2、SPT-3、NISPT-1、NISPT-2、SVT、SVTO、SVTOO、SJT、SJTO、SJTOO、SJTW、SJTOW、SJTOOW、HPN | 3×18AWG |
| SPT-2、SPT-3、SJT、SJTO、SJTOO、SJTW、SJTOW、SJTOOW、HPN | 3×16AWG |
| SPT-3、SJT、SJTO、SJTOO、SJTW、SJTOW、SJTOOW | 3×14AWG |
| SPT-3 | 3×12AWG |
| SPT-3 | 3×10AWG |



美规带保险管两插(1-15p)

Type NO(型号) : SF-209

参数: 2.5A 125V~/5A 125V~

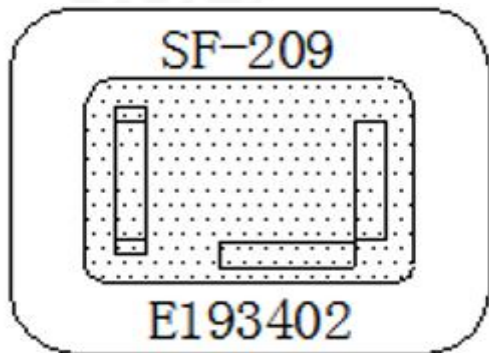

| Applicable Cable(适用电线) | |
|-------------------------|----------------|
| Type of Cable(电线型号) | Cable Size(规格) |
| SPT-2、SPT-2-R、SJT、SJT-R | 2×18AWG |
| SPT-2、SPT-2-R、SJT、SJT-R | 2×16AWG |

美规三插(5-15p)

Type NO(型号) : SF-311

参数: 10A 125V~/13A 125V~/15A 125V



| Applicable Cable(适用电线) | |
|---|----------------|
| Type of Cable(电线型号) | Cable Size(规格) |
| SPT-1、SPT-2、SPT-3、NISPT-1、NISPT-2、SVT、SVTO、SVTOO、SJT、SJTO、SJTOO、SJTW、SJTOW、SJTOOW、HPN | 3×18AWG |
| SPT-2、SPT-3、NISPT-2、SJT、SJTO、SJTOO、SJTW、SJTOW、SJTOOW、HPN | 3×16AWG |
| SPT-3、SJT、SJTO、SJTOO、SJTW、SJTOW、SJTOOW | 3×14AWG |

美规三插(弯形)(5-15p)

Type NO(型号) : SF-303S

参数: 10A 125V~/ 13A 125V~/ 15A 125V~



| Applicable Cable(适用电线) | |
|------------------------|----------------|
| Type of Cable(电线型号) | Cable Size(规格) |
| SVT | 3×18AWG |
| SJT | 3×18AWG |
| SJT | 3×16AWG |
| SJT | 3×14AWG |

美规三插(6-15P)

Type NO(型号) : SF-312

参数: 10A 125V~/13A 125V~/15A 125V



| Applicable Cable(适用电线) | |
|---|----------------|
| Type of Cable(电线型号) | Cable Size(规格) |
| SPT-1、SPT-2、SPT-3、NISPT-1、NISPT-2、SVT、SVTO、SVTOO、SJT、SJTO、SJTOO、SJTW、SJTOW、SJTOOW、HPN | 3×18AWG |
| SPT-2、SPT-3、NISPT-2、SJT、SJTO、SJTOO、SJTW、SJTOW、SJTOOW、HPN | 3×16AWG |
| SPT-3、SJT、SJTO、SJTOO、SJTW、SJTOW、SJTOOW | 3×14AWG |
| SPT-3、SJT、SJTO、SJTOO、SJTW、SJTOW、SJTOOW | 3×12AWG |
| SPT-3、SJT、SJTO、SJTOO、SJTW、SJTOW、SJTOOW | 3×10AWG |

品字尾

Type NO(型号) : SF-304

参数: 10A 125V~/13A 125V~/15A 125V



| Applicable Cable(适用电线) | |
|---|----------------|
| Type of Cable(电线型号) | Cable Size(规格) |
| SVT、SVTO、SVTOO、SJT、 SJTO、SJTOO、SJTW、SJTOW、 SJTOOW、HPN | 3×18AWG |
| SJT、SJTO、JTOO、SJTW、 SJTOW、SJTOOW、HPN | 3×16AWG |
| SJT、SJTO、SJTOO、SJTW、 SJTOW、SJTOOW | 3×14AWG |

美三插母插

Type NO(型号) : SF-306

参数: 13A 125V~/15A 125V~



| Applicable Cable(适用电线) | |
|------------------------|----------------|
| Type of Cable(电线型号) | Cable Size(规格) |
| SJTW | 3×16AWG |
| SJTW | 3×14AWG |

美规延长线插座

Type NO(型号) : SF-305

参数: 10A 125V~/13A 125V~

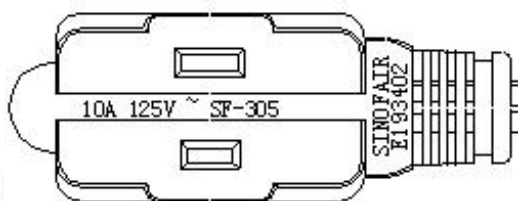

| Applicable Cable(适用电线) | |
|------------------------|----------------|
| Type of Cable(电线型号) | Cable Size(规格) |
| SPT2、NISPT-2 | 2×18AWG |
| SPT2、NISPT-2 | 2×16AWG |

美规转换插(1-15p)

Type NO(型号) : SF-203

参数: 10A 125V~



| Applicable Cable(适用电线) | |
|------------------------|----------------|
| Type of Cable(电线型号) | Cable Size(规格) |
| SPT-2 | 2×18AWG |
| SPT-2 | 2×16AWG |

美规 B 字尾插

Type NO(型号) : SF-206

参数: 10A 125V~/13A 125V~



| Applicable Cable(适用电线) | |
|------------------------|----------------|
| Type of Cable(电线型号) | Cable Size(规格) |
| SPT-1/SPT-2 | 2×18AWG |
| SPT-2 | 2×16AWG |

美规 B 字公插

Type NO(型号) : SF-208

参数: 2.5A 250V~



| Applicable Cable(适用电线) | |
|------------------------|-----------------------|
| Type of Cable(电线型号) | Cable Size(规格) |
| H03VVH2-F | 2×0.5mm ² |
| H03VVH2-F | 2×0.75mm ² |
| H05VVH2-F | 2×0.75mm ² |
| UL SPT-2 | 2×18AWG |

美规 8 字尾弯插

Type NO(型号) : SF-210

参数: 2.5A 125V~/5A 125V~



| | |
|------------------------|----------------|
| Applicable Cable(适用电线) | |
| Type of Cable(电线型号) | Cable Size(规格) |
| NISPT-2 | 2×18AWG |

美规 8 字尾直插

Type NO(型号) : SF-211

参数: 2.5A 125V~/5A 125V~



| Applicable Cable(适用电线) | |
|------------------------|----------------|
| Type of Cable(电线型号) | Cable Size(规格) |
| NISPT-2 | 2×18AWG |
| SPT-2 | 2×18AWG |

UL758电子线系列（档案号：E203032）

| 序号 | 电子线 类型 | 线号 范围 |
|----|------------|-------------|
| 1 | 1015 105°C | 28AWG~10AWG |
| 2 | 1007 80°C | 30AWG~16AWG |
| 3 | 2468 80°C | 32AWG~16AWG |
| 4 | 2464 80°C | 32AWG~16AWG |
| 5 | 21301 | 10AWG~18AWG |
| 6 | 21571 | 10AWG~18AWG |
| 7 | 21219 | 10AWG~18AWG |
| 8 | 2272 60°C | 24AWG~18AWG |

UL62电源线系列(档案号 E193403)

| 序号 | 规格 | 序号 | 规格 |
|----|---------|----|-------|
| 1 | SPT-1 | 9 | ST |
| 2 | NISPT-1 | 10 | SJT |
| 3 | SPT-2 | 11 | SJTW |
| 4 | NISPT-2 | 12 | SJT-R |
| 5 | STP-2-R | 13 | XT |
| 6 | SPT-3 | 14 | XTW |
| 7 | STP-3-R | 15 | CXTW |
| 8 | SVT | | |

ETL (控制号3196604)

| 序号 | 线材 规格 |
|----|-------------------------|
| 1 | SPT-1, SPT-2, SPT-3 |
| 2 | NISPT-1, NISPT-2 |
| 3 | SVT, SJT, SJTW, ST, STW |
| 4 | SVT, SJT, SJTW |

| 序号 | 插头 及组件 规格 |
|----|--------------------------------------|
| 1 | SF-301,SF-303,SF-303S,SF-311,SF-312 |
| 2 | SF-304, SF-210, SF-211 |
| 3 | SF-209 |
| 4 | SF-301+SF-210+配线SPT-2 2*16/18 AWG |
| 5 | SF-301+SF-211+配线SPT-2 2*16/18 AWG |
| 6 | SF-303+SF-304+配线SVT, SJT 2*16/18 AWG |

Sinofair[®]

• Europe 欧洲

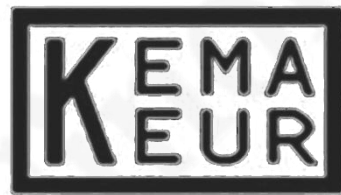

欧洲工具插 (VDE认证)

Type NO(型号) : SF-08

参数: 16A 250V~



| Applicable Cable(适用电线) | |
|------------------------|-----------------------|
| Type of Cable(电线型号) | Cable Size(规格) |
| H03VVH2-F | 2×0.75mm ² |
| H03VV-F | 2×0.75mm ² |
| H05VVH2-F | 2×0.75mm ² |
| H05VV-F | 2×0.75mm ² |
| H05VV-F | 2×1.0mm ² |

欧洲工具插(KEMA认证)

Type NO(型号) : SF-08

参数: 16A 250V~



| Applicable Cable(适用电线) | |
|------------------------|-----------------------|
| Type of Cable(电线型号) | Cable Size(规格) |
| H03VVH2-F | 2×0.75mm ² |
| H03VV-F | 2×0.75mm ² |
| H05VVH2-F | 2×0.75mm ² |
| H05VV-F | 2×0.75mm ² |
| H05VV-F | 2×1.0mm ² |
| H05RR-F | 2×0.75mm ² |
| H05RR-F | 2×1.0mm ² |
| H05RR-F | 2×1.5mm ² |

欧洲两圆插:

Type NO(型号) : SF-09

参数: 2.5A 250V~



| Applicable Cable(适用电线) | |
|------------------------|------------------------------|
| Type of Cable(电线型号) | Cable Size(规格) |
| H03VVH2-F(最长配线 2M) | 2×0.5mm ² VDE/KK |
| H03VV-F(最长配线 2M) | 2×0.5mm ² VDE/KK |
| H03VVH2-F | 2×0.75mm ² KK |
| H03VV-F | 2×0.75mm ² VDE/KK |
| H05VVH2-F | 2×0.75mm ² (KK) |
| H05VV-F | 2×0.75mm ² VDE/KK |

法国弯插

Type NO(型号) : SF-10

参数: 16A 250V~



| Applicable Cable(适用电线) | |
|------------------------|------------------------------|
| Type of Cable(电线型号) | Cable Size(规格) |
| H03VV-F | 3G0.75mm ² VDE/KK |
| H05VV-F | 3G0.75mm ² VDE/KK |
| H05VV-F | 3G1.0mm ² VDE/KK |
| H05VV-F | 3G1.5mm ² VDE/KK |
| H05RR-F | 3G0.75mm ² KK |
| H05RR-F | 3G1.0mm ² KK |
| H05RR-F | 3G1.5mm ² KK |

法国直插

Type NO(型号) : SF-011

参数: 16A 250V~



| Applicable Cable(适用电线) | |
|------------------------|-----------------------|
| Type of Cable(电线型号) | Cable Size(规格) |
| H03VV-F | 3G0.75mm ² |
| H05VV-F | 3G0.75mm ² |
| H05VV-F | 3G1.0mm ² |
| H05VV-F | 3G1.5mm ² |

法国直插 (VDE认证)

Type NO(型号) : SF-11-1

参数: 16A 250V~



| Applicable Cable(适用电线) | |
|------------------------|-----------------------|
| Type of Cable(电线型号) | Cable Size(规格) |
| H05VV-F | 3G0.75mm ² |
| H05VV-F | 3G1.0mm ² |
| H05VV-F | 3G1.5mm ² |

品字尾 (KEMA KEUR认证)

Type NO(型号) : SF-309

参数: 10A 250V~



| Applicable Cable(适用电线) | |
|------------------------|-----------------------|
| Type of Cable(电线型号) | Cable Size(规格) |
| H05VV-F | 3G0.75mm ² |
| H05VV-F | 3G1.0mm ² |
| H05VV-F | 3G1.5mm ² |



欧规8字尾直插

Type NO(型号) : SF-216 (VDE)

SF-308 (KEMA KEUR)

参数: 2.5A 250V~



Applicable Cable(适用电线)

Type of Cable(电线型号)

Cable Size(规格)

H03VVH2-F(MAX 2M)

2×0.5mm²

H03VVH2-F

2×0.75mm²

H05VVH2-F

2×0.75mm²

欧洲8字尾 弯插 (VDE认证)

Type NO(型号) : SF-215

参数: 2.5A 250V~

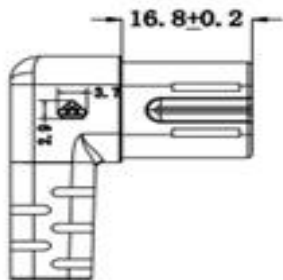

| Applicable Cable(适用电线) | |
|------------------------|-----------------------|
| Type of Cable(电线型号) | Cable Size(规格) |
| H03VVH2-F(MAX 2M) | 2×0.5mm ² |
| H03VVH2-F | 2×0.75mm ² |
| H05VVH2-F | 2×0.75mm ² |

PVC Free 欧洲 两圆插 认证中ing未获得证书

Type NO(型号) : SF-217 无卤插头

参数: 2.5A 250V~

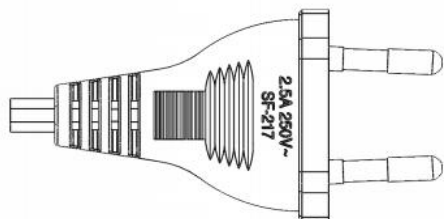
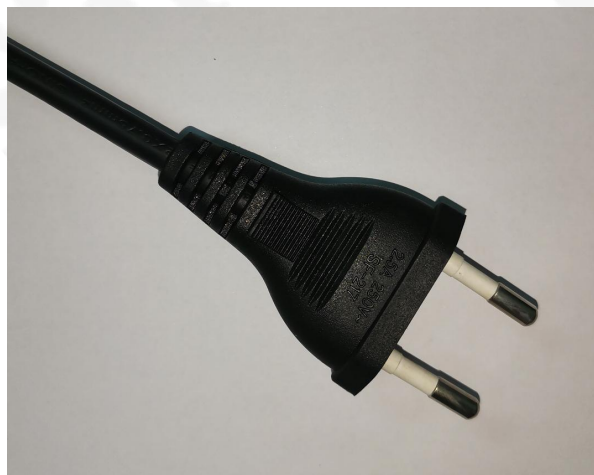

| Applicable Cable(适用电线) | |
|------------------------|-----------------------|
| Type of Cable(电线型号) | Cable Size(规格) |
| H03Z1Z1-F | 2×0.5mm ² |
| H03Z1Z1H2-F | 2×0.5mm ² |
| H03Z1Z1-F | 2×0.75mm ² |
| H03Z1Z1H2-F | 2×0.75mm ² |

欧规电线系列（VDE认证）

| 序号 | 规格 型号 | 备注 |
|----|--|-----|
| 1 | H03VVH2-F 2 x 0.5...0.75mm ² | |
| 2 | H03VV-F 2...3 x 0.5...0.75mm ² | |
| 3 | H05VVH2-F 2 x 0.75...1.0mm ² | |
| 4 | H05VV-F 2...5 x 0.75...4 mm ² | |
| 5 | H05V-K 1 x 0.5...1.0mm ² | 电子线 |
| 6 | 03VVH2-F 2 x 0.5...0.75mm ² | 透明色 |
| 7 | 03VV-F 2 x 0.5~0.75mm ² | 透明色 |
| 8 | 05VVH2-F 2 x 0,75...1,0 mm ² | 透明色 |
| 9 | 05VV-F 2...3 x 0,75...1,5 mm ² | 透明色 |
| 10 | H03Z1Z1-F 2...3 x 0,5...0,75 mm ² | 无卤线 |
| 11 | H03Z1Z1H2-F 2 x 0,5...0,75 mm ² | 无卤线 |

Sinofair[®]

Korea 韩国



韩国两圆插

Type NO(型号) : SF-21

参数: 2.5A 250V~



| Applicable Cable(适用电线) | |
|------------------------|-----------------------|
| Type of Cable(电线型号) | Cable Size(规格) |
| 60227 IEC 52 H03VVH2-F | 2×0.5mm ² |
| 60227 IEC 52 H03VV-F | 2×0.5mm ² |
| 60227 IEC 52 H03VVH2-F | 2×0.75mm ² |
| 60227 IEC 52 H03VV-F | 2×0.75mm ² |
| 60227 IEC 53 H05VVH2-F | 2×0.75mm ² |
| 60227 IEC 53 H05VV-F | 2×0.75mm ² |

韩国工具插

Type NO(型号) : SF-22

参数: 16A 250V~



| Applicable Cable(适用电线) | |
|------------------------|-----------------------|
| Type of Cable(电线型号) | Cable Size(规格) |
| 60227 IEC 52 H03VVH2-F | 2×0.75mm ² |
| 60227 IEC 52 H03VV-F | 2×0.75mm ² |
| 60227 IEC 53 H05VVH2-F | 2×0.75mm ² |
| 60227 IEC 53 H05VV-F | 2×0.75mm ² |
| 60227 IEC 53 H05VVH2-F | 2×1.0mm ² |
| 60227 IEC 53 H05VV-F | 2×1.0mm ² |

韩国弯插

Type NO(型号) : SF-23

参数: 16A 250V~



| Applicable Cable(适用电线) | |
|------------------------|-----------------------|
| Type of Cable(电线型号) | Cable Size(规格) |
| 60227 IEC 52 H03VV-F | 3×0.75mm ² |
| 60227 IEC 53 H05VV-F | 3×0.75mm ² |
| 60227 IEC 53 H05VV-F | 3×1.0mm ² |
| 60227 IEC 53 H05VV-F | 3×1.5mm ² |



韩国直插

Type NO(型号) : SF-11-1

参数: 16A 250V~

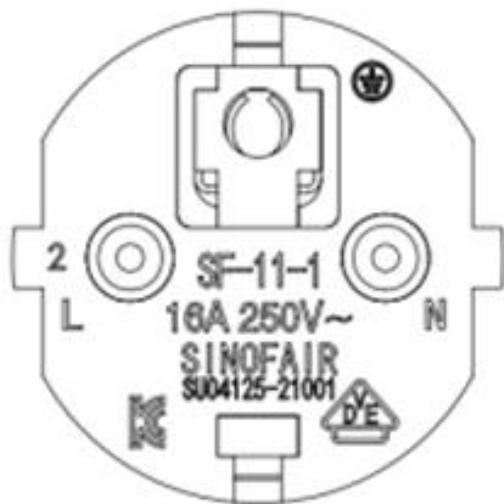

Applicable Cable(适用电线)

| Type of Cable(电线型号) | Cable Size(规格) |
|----------------------|-----------------------|
| 60227 IEC 52 H03VV-F | 3×0.75mm ² |
| 60227 IEC 53 H05VV-F | 3×1.0mm ² |
| 60227 IEC 53 H05VV-F | 3×1.5mm ² |

韩国8字尾插

Type NO(型号) : SF-308

参数: 2.5A 250V~



| Applicable Cable(适用电线) | |
|------------------------|-----------------------|
| Type of Cable(电线型号) | Cable Size(规格) |
| 60227 IEC 52 H03VVH2-F | 2×0.5mm ² |
| 60227 IEC 52 H03VVH2-F | 2×0.75mm ² |
| 60227 IEC 53 H05VVH2-F | 2×0.75mm ² |

韩国品字尾插

Type NO(型号) : SF-309

参数: 10 A 250V~

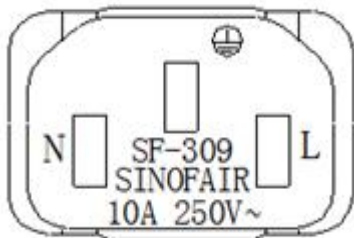

| Applicable Cable(适用电线) | |
|------------------------|-----------------------|
| Type of Cable(电线型号) | Cable Size(规格) |
| 60227 IEC 53 H05VV-F | 3×0.75mm ² |
| 60227 IEC 53 H05VV-F | 3×1.0mm ² |
| 60227 IEC 53 H05VV-F | 3×1.5mm ² |

Sinofair[®]

Australia 澳洲



澳洲两插

Type NO(型号) : SF-601

参数: 7.5A 250V~/10A 250V~



| Applicable Cable(适用电线) | |
|------------------------|-----------------------|
| Type of Cable(电线型号) | Cable Size(规格) |
| H03VVH2-F | 2×0.75mm ² |
| H03VV-F | 2×0.75mm ² |
| H05VVH2-F | 2×0.75mm ² |
| H05VV-F | 2×0.75mm ² |
| H05VVH2-F | 2×1.0mm ² |
| H05VV-F | 2×1.0mm ² |

澳洲三插

Type NO(型号) : SF-602

参数: 7.5A 250V~/10A 250V~



| Applicable Cable(适用电线) | |
|------------------------|------------------------|
| Type of Cable(电线型号) | Cable Size(规格) |
| H03VV-F | 3G 0.75mm ² |
| H05VV-F | 3G 0.75mm ² |
| H05VV-F | 3G 1.0mm ² |
| H05VV-F | 3G 1.5mm ² |

Sinofair[®]

England 英国

Singapore 新加坡



英规两插(ISOD不带接地)

Type NO(型号) : SF-603

参数: 3A 250V~/6A 250V~/10A 250V~

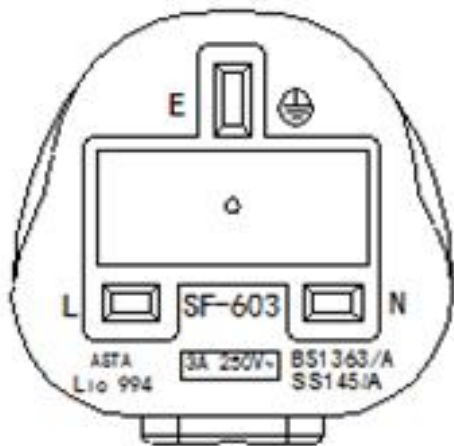

Applicable Cable(适用电线)

| Type of Cable(电线型号) | Cable Size(规格) |
|---------------------|-----------------------|
| H03VVH2-F | 2×0.5mm ² |
| H03VV-F | 2×0.5mm ² |
| H03VVH2-F | 2×0.75mm ² |
| H03VV-F | 2×0.75mm ² |
| H05VVH2-F | 2×0.75mm ² |
| H05VV-F | 2×0.75mm ² |
| H05VVH2-F | 2×1.0mm ² |
| H05VV-F | 2×1.0mm ² |



英规两插(E Pin 带接地)

Type NO(型号) : SF-603

参数: 3A 250V~/6A 250V~/10A 250V~/13A 250V~

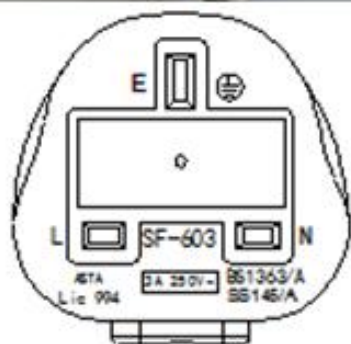

| Applicable Cable(适用电线) | |
|------------------------|-----------------------|
| Type of Cable(电线型号) | Cable Size(规格) |
| H03VV-F | 3×0.5mm ² |
| H03VV-F | 3×0.75mm ² |
| H05VV-F | 3×0.75mm ² |
| H05VV-F | 3×1.0mm ² |
| H05VV-F | 3×1.5mm ² |

Sinofair[®]

Japan 日本



日本插

Type NO(型号) : SF-207

参数: 7A/125V~



| Applicable Cable(适用电线) | |
|------------------------|-----------------------|
| Type of Cable(电线型号) | Cable Size(规格) |
| H03VVH2-F | 2×0.75mm ² |

日规电线系列（JET认证）

| 序号 | 规格 型号 | 备注 |
|----|---------------------------------|----|
| 1 | H03VVH2-F 2x0.75mm ² | |
| 2 | VCTFK 2x0.75mm ² | |
| 3 | VFF 2x0.75mm ² | |

Sinofair[®]

Taiwan 台湾

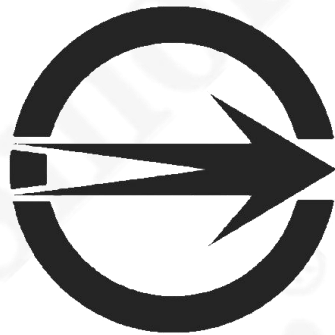

台湾插(非极性/极性)

Type NO(型号) : SF-205

参数: 2.5A/ 6A 125V~



| Applicable Cable(适用电线) | |
|------------------------|-----------------------|
| Type of Cable(电线型号) | Cable Size(规格) |
| 60227 IEC 52 H03VVH2-F | 2×0.5mm ² |
| 60227 IEC 52 H03VV-F | 2×0.5mm ² |
| 60227 IEC 52 H03VVH2-F | 2×0.75mm ² |
| 60227 IEC 52 H03VV-F | 2×0.75mm ² |

台湾2插组件(非极性/极性)

Type NO(型号) : SF-205+SF-204 (8字尾直插)

参数: 6A/2.5A 125V~



| Applicable Cable(适用电线) | |
|------------------------|--------------------------------------|
| Type of Cable(电线型号) | Cable Size(规格) |
| 60227 IEC 52 H03VVH2-F | 2×0.75mm ² (6A) |
| 60227 IEC 52 H03VVH2-F | 2X0.5mm ² (2.5A) 配线不得超过2米 |

台湾插(非极性/极性)

Type NO(型号) : SF-321

参数: 6A 125V~/ 10A 125V~/ 15A 125V~



| Applicable Cable(适用电线) | |
|------------------------|-----------------------|
| Type of Cable(电线型号) | Cable Size(规格) |
| 60227 IEC 53 H05VV-F | 3×0.75mm ² |
| 60227 IEC 53 H05VV-F | 3×1.0mm ² |
| 60227 IEC 53 H05VV-F | 3×1.5mm ² |
| 60227 IEC 52 H03VV-F | 3×0.75mm ² |

台湾3插组件

Type NO(型号) : SF-321+SF-322 (品字尾)

参数: 6A 125V~/ 10A 125V~/ 15A 125V~



| Applicable Cable(适用电线) | |
|------------------------|-----------------------|
| Type of Cable(电线型号) | Cable Size(规格) |
| 60227 IEC 53 H05VV-F | 3×0.75mm ² |
| 60227 IEC 53 H05VV-F | 3×1.0mm ² |
| 60227 IEC 53 H05VV-F | 3×1.5mm ² |
| 60227 IEC 52 H03VV-F | 3×0.75mm ² |

- 充电插头
- **DC接插件**
- 开关
- 编织线

USB充电插

Type NO(型号) : SF-007

参数: 2.5A 125V~



| Applicable Cable(适用电线) | |
|------------------------|----------------|
| Type of Cable(电线型号) | Cable Size(规格) |
| UL 2468 | 2×18AWG |
| UL 2468 | 2×20AWG |
| UL 2468 | 2×22AWG |
| UL 2468 | 2×24AWG |
| 非标类圆线 | |

5.5DC插头

Type NO(型号) : SF-006

参数: 2.5A 125V~



| Applicable Cable(适用电线) | |
|------------------------|----------------|
| Type of Cable(电线型号) | Cable Size(规格) |
| UL 2468 | 2×18AWG |
| UL 2468 | 2×20AWG |
| UL 2468 | 2×22AWG |
| UL 2468 | 2×24AWG |
| 非标类圆线 | |

3.5DC插头

Type NO(型号) : SF-71

参数: 2.5A 125V~



| Applicable Cable(适用电线) | |
|------------------------|-----------------------|
| Type of Cable(电线型号) | Cable Size(规格) |
| UL 2468 | 2×18AWG |
| UL 2468 | 2×20AWG |
| UL 2468 | 2×22AWG |
| UL 2468 | 2×24AWG |
| H03VVH2-F | 2×0.5mm ² |
| H03VVH2-F | 2×0.75mm ² |
| 非标类圆线 | |

圆形01插

Type NO(型号) : SF-001

参数: 2.5A 125V~



| Applicable Cable(适用电线) | |
|------------------------|-----------------------|
| Type of Cable(电线型号) | Cable Size(规格) |
| UL 2468 | 2×18AWG |
| UL 2468 | 2×20AWG |
| UL 2468 | 2×22AWG |
| UL 2468 | 2×24AWG |
| UL SPT-1 | 2×18AWG |
| H03VVH2-F | 2×0.5mm ² |
| H03VVH2-F | 2×0.75mm ² |

部分配套装配的开关类型

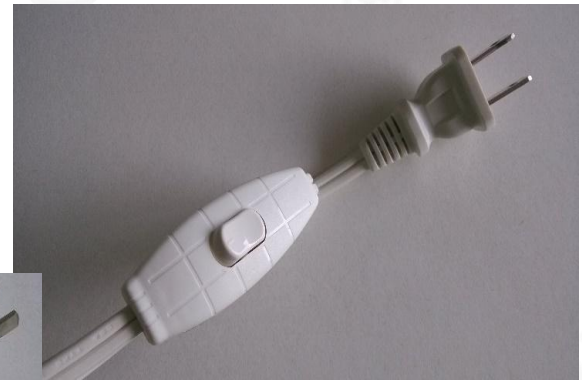

Sinofair®

各色编织线，可配套各国安规电源线



部分证书展示



Sinofair[®]



期待您的关注！！！！